



国家电网  
STATE GRID

国网四川省电力公司电力科学研究院  
STATE GRID SICHUAN ELECTRIC POWER RESEARCH INSTITUTE

# *Guide for Field PD Tests for Liquid-filled Power Transformers*



Sichuan Electric Power Research Institute  
State Grid Corporation of China  
Oct. 2016



# Contents

**1**

**Background**

**2**

**Comparison with IEEE ( IEC ) standards**

**3**

**Technological Capability**

**4**

**Main Contents**

**5**

**Case Study**



## BACKGROUND



Partial discharge can severely harm the insulation of transformers, therefore PD tests are required after the manufacturing sector, and the PD level shall not violate the limit of the standards.

### Necessity of Field PD tests on transformers

- In order to detect defects caused by the transportation and the re-assembling sector, field PD tests are implemented.
- For the transformers assembled on site, the field PD test is necessary.
- PD test is also used to diagnose the insulation state of the transformer when it experiences poor working conditions



## Necessity of a guide for field PD tests

- Field PD tests for transformers are implemented widely.
- Implementing PD tests in a substation/converter station is distinctly different than that carried out in a factory or a laboratory due to differences in test environment and testing equipment.
- Accurate PD analysis and identification can provide the right way to handle the defects of a transformer. Incorrect analytical results may result in tremendous capital loss and waste of human resources.
- Since the voltage level and capacity of power transformers continue to be improved, field PD tests are becoming increasingly important. Particularly, field PD tests for 500kV-1000kV ( e.g., DC  $\pm 800$ kV ) power transformers become more difficult due to higher test voltage and more reactive power compensation.





## 6 Related standards

- IEC 60270 2000 High-voltage test techniques-Partial discharge measurements
- IEC 60076-3 2013 Power transformers-Part 3 : Insulation levels, dielectric tests and external clearances in air
- IEEE C57.113 2010 IEEE recommended practice for partial discharge measurement in liquid-filled power transformers and shunt reactors
- IEEE C57.124 1991(R2002) IEEE recommended practice for the detection of partial discharge and the measurement of apparent charge in dry-type transformers
- IEEE C57.127 2007 IEEE guide for the detection and location of acoustic emissions from partial discharges in oil-immersed power transformers and reactors
- IEEE C57.152 2013 IEEE guide for diagnostic field testing of fluid-filled power transformers, regulators, and reactors



## IEEE C57.127 2007

provides a guideline for detecting partial discharge using the acoustic method, while ours is based on a different test method, i.e., the pulse current method.



## IEEE C57.152 2013

**IEEE C57.152 roughly introduces the diagnostic field testing of fluid-immersed power transformers, regulators and reactors; however, it merely introduces PD measurements in main oil tanks and bushings in Clause 7.2.16 and 7.3.4, respectively, and detailed measurement steps of carrying out a PD test are not described.**



## IEC 60076-3 2013

**Although introducing the test procedures of transformer PD detection in Clause 11.3 and Annex A quoting IEC 60270, IEC 60076-3 centers on insulation level, dielectric tests and external clearances in air of power transformers.**





## IEEE C57.124 1991(R2002)

**IEEE C57.124 is an early-developed standard that focuses on the dry-type transformers and involves no specific test steps.**



## IEC 60270 and IEEE C57.113

IEC 60270 and IEEE C57.113 include more details compared with other standards concerning PD tests, and both give overall specifications on PD measurement circuits and PD test methods. However, it is the detailed specifications on methods of interference suppression and PD pattern recognition that they lack. Further, special transformers such as converter transformers and traction transformers, etc. are not covered.



## The proposal

**This proposal supplements IEC 60270 and IEEE C57.113 and focuses on field tests. The points covered in this proposal but not in the exiting standards include:**

- **wiring methods of field PD tests for transformers of different types and voltage levels.**
- **different approaches of PD positioning that is operable for testing personnel.**
- **operable approaches to suppress interferences from space, sources, testing equipment, and etc.**
- **PD identification (PD pattern recognition) based on single pulse analysis.**



- It has been over 20 years since field PD tests were first introduced into China's power transformer industry; presently, the voltage level of power transformers ranges from AC 110kV to 1000kV, and DC 400kV to 800kV.
- For power transformers rated 500kV or below, the PD level in the field test must not exceed 100pC, for UHV DC&AC power transformers, the PD level must be within 300pC.
- From experience in the field tests over the decades, a great many insulation defects were detected.
- Therefore, we have accumulated a lot of data and experience in the aspects of test equipment settings, interference suppressing techniques, PD identification and positioning as well as defect handling.

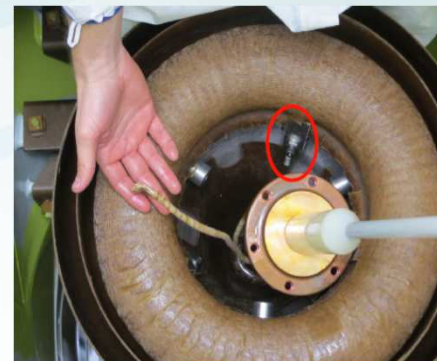



# Main Contents

## Content I: Requirments for PD test equipment

Such parameters as power supply, reactive compensation system, measuring system and calibration system are recommended for field PD tests by considering convenience and accuracy factors.

The way of wiring is recommended according to the type and voltage level of a power transformer by taking account of field test environment.

## Content II: The wiring of field PD tests





# Main Contents

**Methods of Calibration are recommended for field PD tests, especially when there are strong interferences.**

**Content III:  
Calibration of  
field PD test**

**Content IV:  
Interference  
identification  
and suppression**

**Interference arising from grounding, space, source of power, corona etc., are common for field PD tests. The methods of identifying interferences and the measures to eliminate impact of interferences are provided.**



# Main Contents

## Content V: Typical PD pulse analysis

A set of typical PD pulses and interference signals are provided and analytical techniques are recommended for the identification of any typical PD pulse.

Method of partial discharge positioning by using electrical, acoustical or combined technologies as well as the related requirements are recommended.

## Content VI: Positioning of partial discharge



## Case I: PD analysis of a converter transformer

**brief introduction:** In the PD test for a YY-B converter transformer (single phase) at the LV end of pole I of a converter station, the PD magnitude was found exceeding the specified value. The PD pulses are illustrated in Fig.1. Partial discharge was detected at the valve side of the transformer with an inception voltage of 52kV and extinction voltage of 50kV. The PD magnitude measured at the line side is 10000pC starting at 52kV and rapidly increased with the rise of the test voltage. The magnitude of the PD activity almost doubled when the voltage increased by 4kV to 5kV.

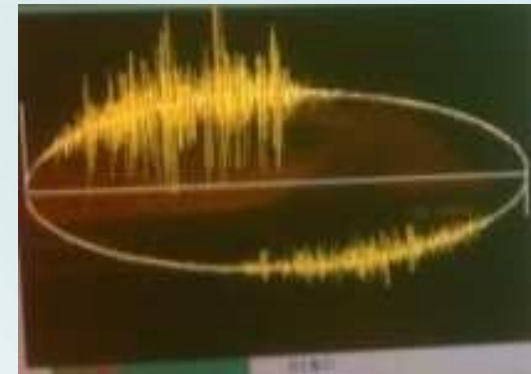
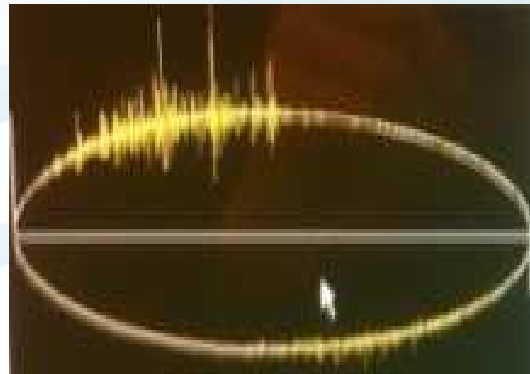



# Case Study

## Case I: PD analysis of converter transformer

**Identification of interference:** Interference signals were identified using ultraviolet imaging and ultrasonic means. Based on typical wave analysis, the partial discharge is identified as internal discharge when external interferences (including corona, external electromagnetic interferences, suspended potential interferences and interferences from the test circuit) are excluded.

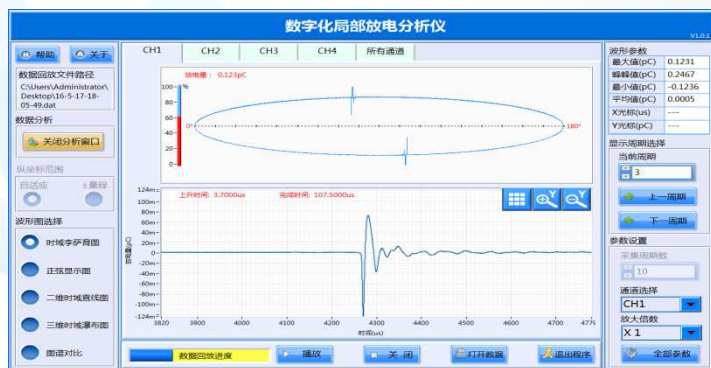



## Case I: PD analysis of converter transformer

**Partial discharge analysis:** By observing the inception and extinction of partial discharge as well as its growing trend, combined with approaches like single wave analysis, it is concluded that the partial discharge is highly concerned with creepage phenomenon on insulation paper.





# Case Study

## Case I: PD analysis of converter transformer

### Partial discharge positioning:

- Step I: the Partial discharge is identified at the line side of the converter transformer by measuring and computing the transfer ratios among multiple sampling points.

Table 1 Transfer ratio of the transformer

$k_{p-s}$	$k_{p-s}$	Real PD ratio (line side-valve side)
500:125	500:95	10000:3200



## Case I: PD analysis of converter transformer

### Partial discharge positioning:

- Step II: The potential changing approach is used, i.e., observing the changes of the inception and extinction voltage as well as the magnitude of partial discharge by changing the turn ratio via the OLTC or energizing at the tail end of the valve winding. And it is confirmed that the discharge is unlikely to be a turn-turn discharge, therefore the discharge is assured at the other end of the winding against the neutral.

Position of OLTC	Inception voltage/kV (Valve/Line)	extinction voltage/kV (Valve/Line)	discharge magnitude at the line side/pC	discharge magnitude at the valve side/pC
1	45/179.1	42/167	10000	3500
15	52/178.9	48/165	10000	3000
24	58.3/180	53/163	10000	4000
29	62/180.7	58/168	10000	3500
1(energized at tail end)	45/179.1	38/151	12000	6000



# Case Study

## Case I: PD analysis of converter transformer

### Partial discharge positioning:

Step III: By energizing at the tail end of the winding, the voltage between the line-side winding and the valve-side winding has been changed (see the fig.), therefore discharge ishe unlikely to take place in between.

Step IV: The partial discharge is judged to be located in the turret of HV bushing by using the ultrasonic device.

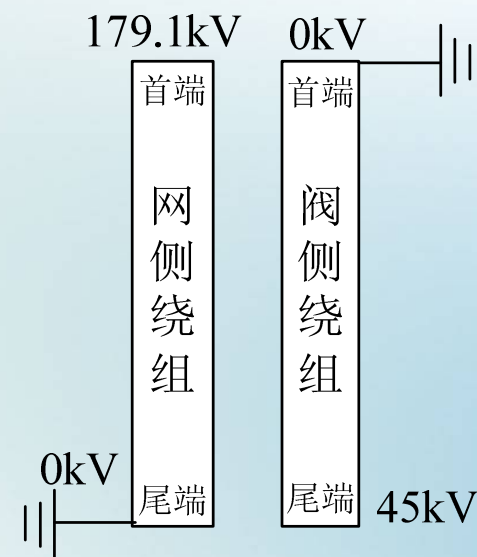
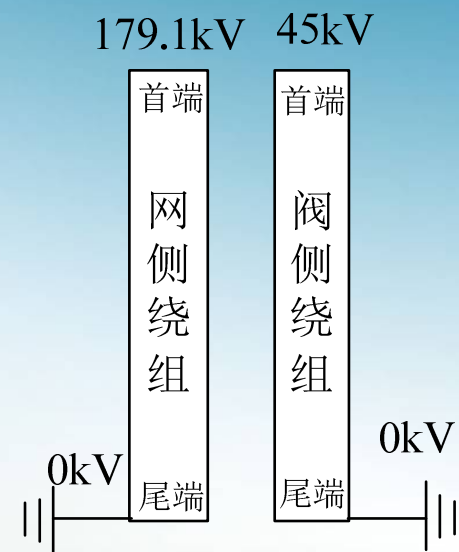
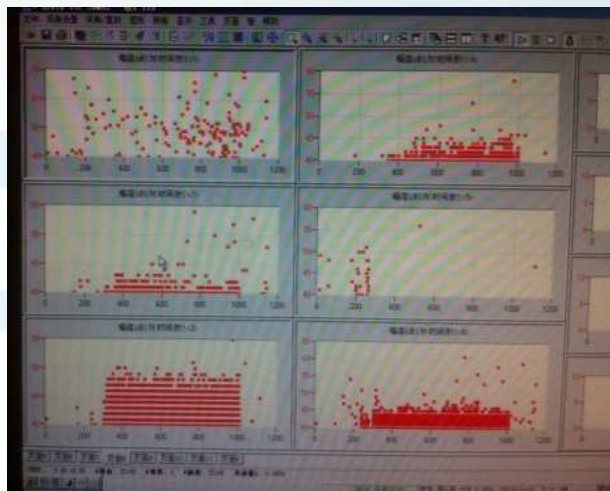
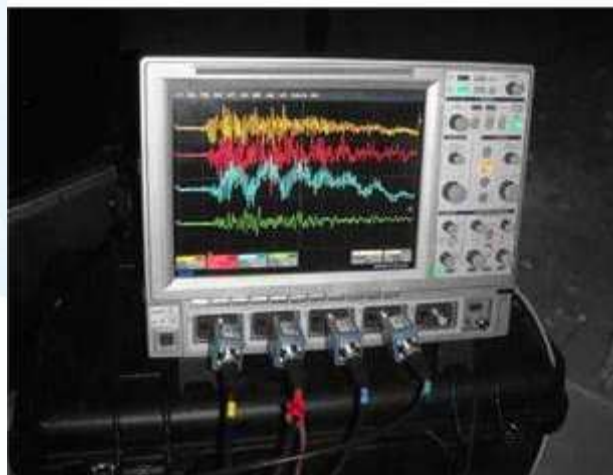



# Case Study

## Case II: Bubble discharge in the oil due to poor installation quality

**brief introduction:** Due to shipping delays, time for field installation of the transformer was compressed, which successively resulted in poor installation quality and ended up as detection of partial discharge that failed to meet the specifications.

When the test voltage rises to  $0.5U_m / \sqrt{3}$  , the partial discharge level rises to 6000pC.

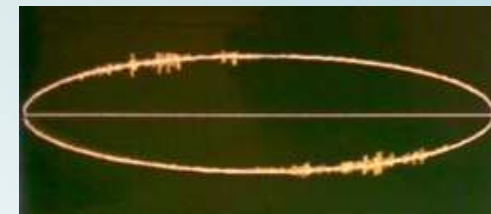
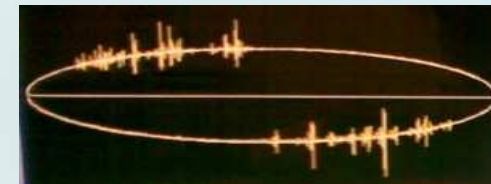
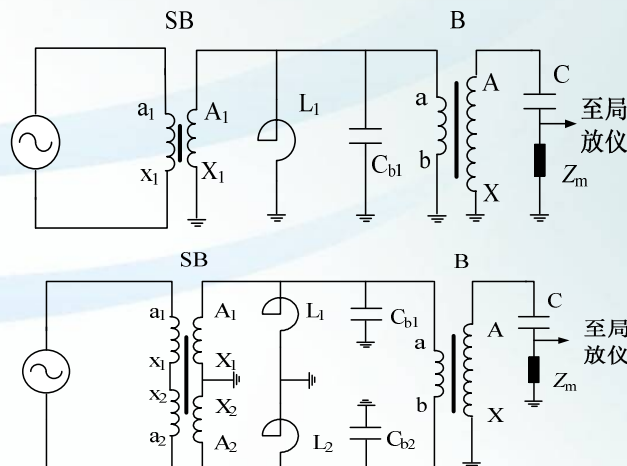



## Case Study

### Case II: Bubble discharge in the oil due to poor installation quality

#### Analysis and handling of the partial discharge :

- By means of changing wiring of the test, using ultraviolet detection, and combined with computation of the transfer ratio, the partial discharge is judged to be located at the line side.
- By analyzing the features of the pulse and the inception & extinction voltage, it is concluded that the discharge takes place inside the transformer tank because of residue bubbles.
- Treatment of abnormal partial discharge: force the oil to circulate by using a submersible pump, and implement the PD test again until the oil cools naturally and release all the gas. It was found that the inception voltage remained but the PD magnitude was reduced to around 3000pC (half of the original magnitude). When vacuum pumping and heated oil circulating were further adopted, the PD magnitude eventually passed the field PD test.





国家电网  
STATE GRID

国网四川省电力公司电力科学研究院  
STATE GRID SICHUAN ELECTRIC POWER RESEARCH INSTITUTE



# The end !

*THANK YOU!*